

OFERTA PRET NORVICUART GROSIME 4-6 CM SI LATIME DE 600 CM

I. GRUPA A

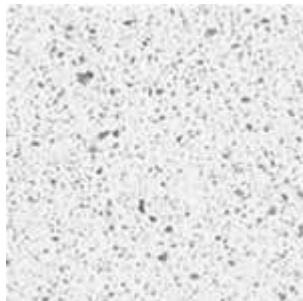

LUZ DE LUNA

Pret: 173 EUR/ml (gr. 4 cm);
201 EUR/ml (gr. 6 cm)

II. GRUPA B

ELEGANCIA BLANCA	PRESTIGIO	SINFONIA BLANCA
ALEGRIA	ILUSION	DULCE DELIRIO
SONRISA	FANTASIA	ESPIRITU DEL VALLE

Norvinia SRL

Brasov: Str. Calea Bucuresti nr. 102, Tel/Fax: 0268-477440, Str. Turnului nr 5, Tel/Fax: 0268-548093
Bucuresti: Home Design Mall - Stand 114-115, B-dul Ghencea nr. 126-132, Tel/Fax: 021-4131157
Cluj-Napoca: Str. Calea Turzii nr. 74-76, Tel/Fax: 0264-430134
Mail: mobilier@norvinia.ro, www.norvinia.ro, J08/514/1999, CF: R11846413

		
PRIVILEGIO	PLOMO	RIO
		
	CAFE	













Pret: 194 EUR/ml (gr. 4 cm);
225 EUR/ml (gr. 6 cm)

III. GRUPA C

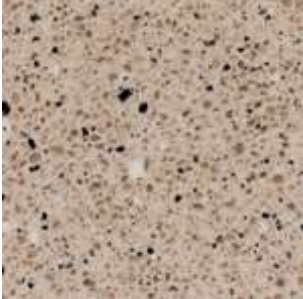
		
DELICATEZ BLANCA	PURA TERNURA *	ORQUIDEA BLANCA
		
SATEN BLANCO *	SUEÑO BLANCO *	BRISA FINA *

Norvinia SRL

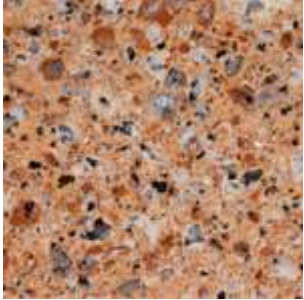
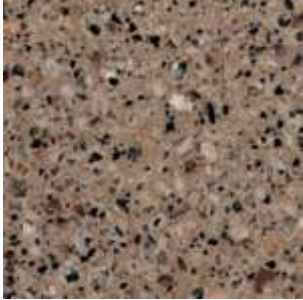
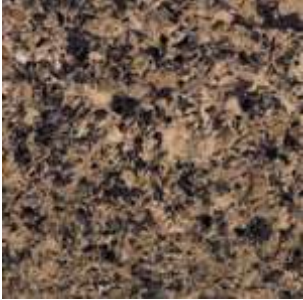
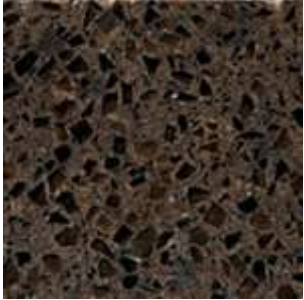
Brasov: Str. Calea Bucuresti nr. 102, Tel/Fax: 0268-477440, Str. Turnului nr 5, Tel/Fax: 0268-548093
Bucuresti: Home Design Mall - Stand 114-115, B-dul Ghencea nr. 126-132, Tel/Fax: 021-4131157
Cluj-Napoca: Str. Calea Turzii nr. 74-76, Tel/Fax: 0264-430134
Mail: mobilier@norvinia.ro, www.norvinia.ro, J08/514/1999, CF: R11846413

		
FIEL ABRAZO	AZUCAR BLANCO *	FLOR *
		
AZUCAR MORENO	FELICIDAD *	TROPICAL *
		
PERLA *	PLAYA *	GRANO DE CAFE *
		
MADRE TIERRA *	CARMELITA *	CANELO
		
FIESTA DE COLORES *	CASTAÑA *	EXTRAVAGANCIA





Norvinia SRL

Brasov: Str. Calea Bucuresti nr. 102, Tel/Fax: 0268-477440, Str. Turnului nr 5, Tel/Fax: 0268-548093
 Bucuresti: Home Design Mall - Stand 114-115, B-dul Ghencea nr. 126-132, Tel/Fax: 021-4131157
 Cluj-Napoca: Str. Calea Turzii nr. 74-76, Tel/Fax: 0264-430134
 Mail: mobilier@norvinia.ro, www.norvinia.ro, J08/514/1999, CF: R11846413

		
AIRE *	PLATEADO *	NOCHE *
		
GOTA DEL PARAISO *	PRIMAVERA	VERDE OSCURO *
		
NARANJA	OPTIMISMO *	VITALIDAD *
		
MARGARITA	CIELO AZUL	REINA
		
SILVESTRE	NATURALEZA *	SERENIDAD

Norvinia SRL

Brasov: Str. Calea Bucuresti nr. 102, Tel/Fax: 0268-477440, Str. Turnului nr 5, Tel/Fax: 0268-548093
 Bucuresti: Home Design Mall - Stand 114-115, B-dul Ghencea nr. 126-132, Tel/Fax: 021-4131157
 Cluj-Napoca: Str. Calea Turzii nr. 74-76, Tel/Fax: 0264-430134
 Mail: mobilier@norvinia.ro, www.norvinia.ro, J08/514/1999, CF: R11846413

		
AISLAMIENTO	SILENCIO *	INFINITO *
		
SOLEDAD		





Pret: 218 EUR/ml (gr. 4 cm);
253 EUR/ml (gr. 6 cm)

IV. GRUPA D

		
SORPRESA DE INVIERNO	NIEVE	NUBE *
		
IRIS BLANCO *	LUZ AZUL *	LUZ ROJA *

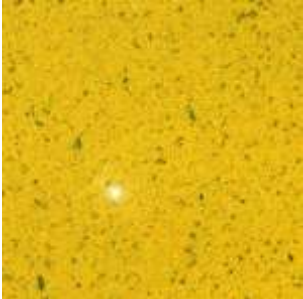
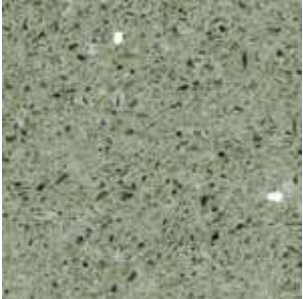
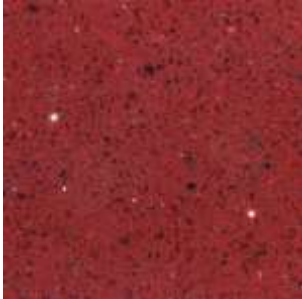
Norvinia SRL

Brasov: Str. Calea Bucuresti nr. 102, Tel/Fax: 0268-477440, Str. Turnului nr 5, Tel/Fax: 0268-548093
Bucuresti: Home Design Mall - Stand 114-115, B-dul Ghencea nr. 126-132, Tel/Fax: 021-4131157
Cluj-Napoca: Str. Calea Turzii nr. 74-76, Tel/Fax: 0264-430134
Mail: mobilier@norvinia.ro, www.norvinia.ro, J08/514/1999, CF: R11846413

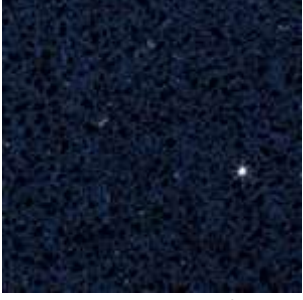
		
LUZ AMARILLA *	LUZ VERDE *	LUZ DE PASION *
		
GRISACEO *	OLIVO *	ROJO SANGRE *
		
ANARANJADO	AZUL MARINO *	DULZURA *
		
TIERRA *	LUZ MARRON	LUZ NEGRA
		
	LUZ MARINA *	



Pret: 251 EUR/ml (gr. 4 cm);
291 EUR/ml (gr. 6 cm)

Norvinia SRL

Brasov: Str. Calea Bucuresti nr. 102, Tel/Fax: 0268-477440, Str. Turnului nr 5, Tel/Fax: 0268-548093
Bucuresti: Home Design Mall - Stand 114-115, B-dul Ghencea nr. 126-132, Tel/Fax: 021-4131157
Cluj-Napoca: Str. Calea Turzii nr. 74-76, Tel/Fax: 0264-430134
Mail: mobilier@norvinia.ro, www.norvinia.ro, J08/514/1999, CF: R11846413

- * comanda minima este de 2,5 ml;
- * blaturile mai mici de 2.50 ml se comanda cu acordul fabricii sau se comercializeaza la un pret cu 50% mai mare decat pretul de lista.
- * pretul este pentru metru liniar (60 cm) ;
- * preturile de mai sus se aplica clientilor ce comanda si mobilier Norvinia. In caz contrar la pretul de lista de adauga 30%
- * pentru insule pretul creste cu 15% fata de un blat obisnuit
- * pentru latimi mai mari de 600-750 cm pretul creste cu 30% fata de pretul de lista
- * pretul include instalarea si transportul pentru Bucuresti, Brasov si Cluj (pentru alte orase se percepe taxa);
- * preturile nu includ TVA.

LISTA PRET INALTATOR SI PLACARE

 Inaltator	Inaltime 4cm	Inclus in pret
	Inaltime >4 cm	15 EUR/ml
 Placare	Grupa A	
	Gr 2 cm (cu latimi de ~ 600 mm)	103 EUR/ml
	Grupa B	
	Gr 2 cm (cu latimi de ~ 600 mm)	125 EUR/ml
	Grupa C	
	Gr 2 cm (cu latimi de ~ 600 mm)	152 EUR/ml
	Grupa D	
	Gr 2 cm (cu latimi de ~ 600 mm)	189 EUR/ml

Norvinia SRL

Brasov: Str. Calea Bucuresti nr. 102, Tel/Fax: 0268-477440, Str. Turnului nr 5, Tel/Fax: 0268-548093
 Bucuresti: Home Design Mall - Stand 114-115, B-dul Ghencea nr. 126-132, Tel/Fax: 021-4131157
 Cluj-Napoca: Str. Calea Turzii nr. 74-76, Tel/Fax: 0264-430134
 Mail: mobilier@norvinia.ro, www.norvinia.ro, J08/514/1999, CF: R11846413

PROFIL

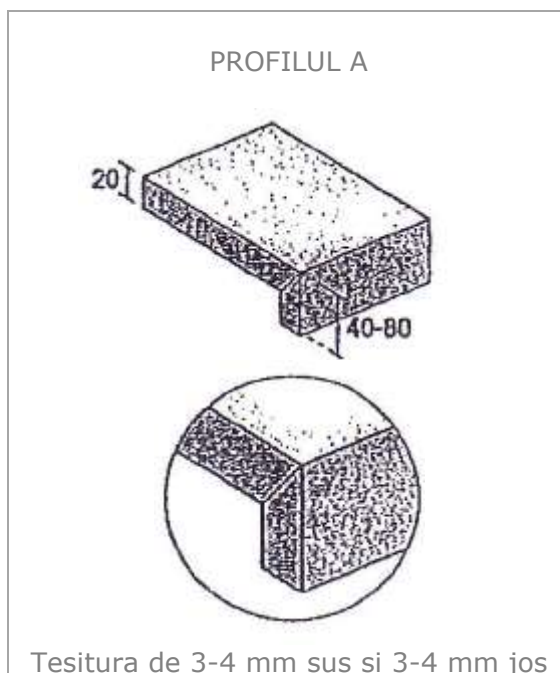

DECUPAJE BLAT

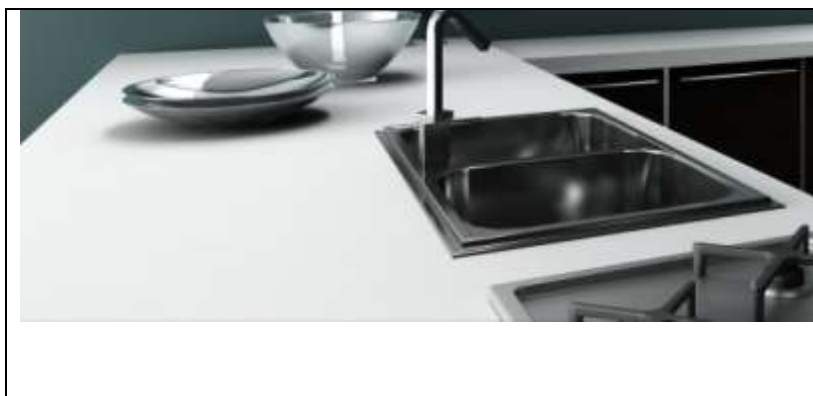

Inclus in pret, fara
finisaje.
Incluse in pret sunt si
decupajele pentru plita,
chiuveta, tevi gaz,
robinet.

**Atentie! Nu se
executa decupaje
sottotop**

Norvinia SRL

Brasov: Str. Calea Bucuresti nr. 102, Tel/Fax: 0268-477440, Str. Turnului nr 5, Tel/Fax: 0268-548093
Bucuresti: Home Design Mall - Stand 114-115, B-dul Ghencea nr. 126-132, Tel/Fax: 021-4131157
Cluj-Napoca: Str. Calea Turzii nr. 74-76, Tel/Fax: 0264-430134
Mail: mobilier@norvinia.ro, www.norvinia.ro, J08/514/1999, CF: R11846413

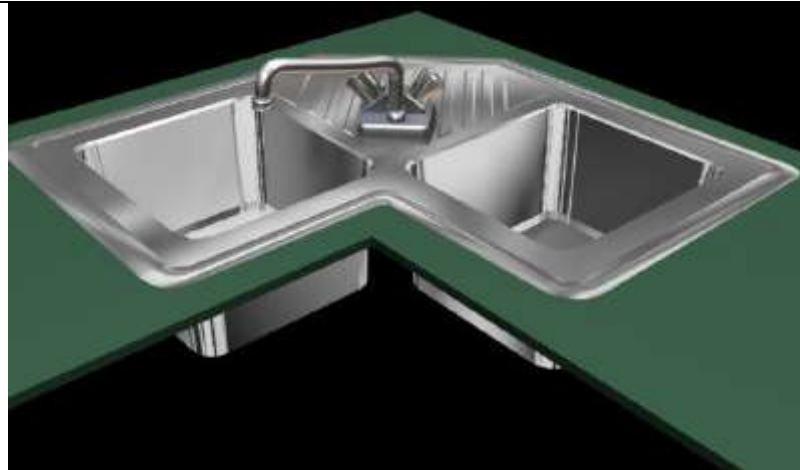

Inclus in pret, fara
finisaje
900/900mm
1000/1000 mm



Inclus in pret, fara
finisaje

LUCRARI SPECIALE BLAT

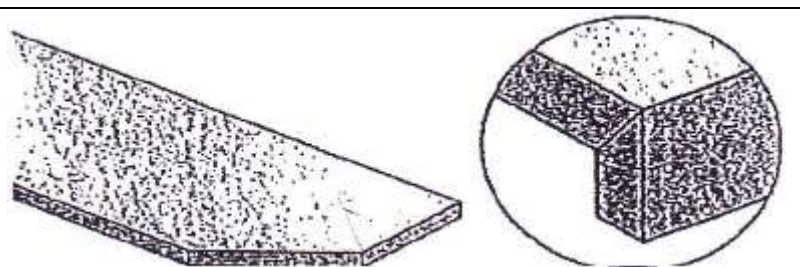

Terminatie tesire blat
rotunda sau dreapta 80
EUR/buc.

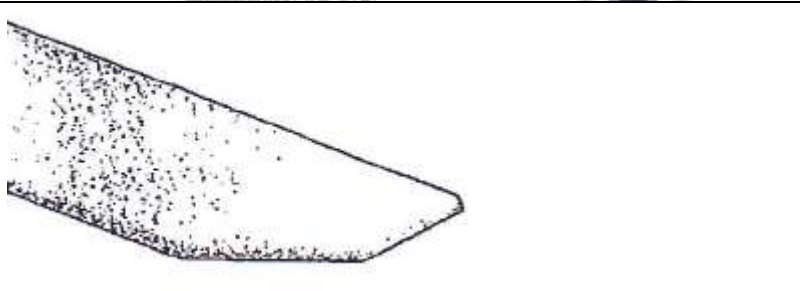

Se executa doar pentru
grosimi de 4-6 cm
Tesitura de 3-4 mm
sus su jos raza de 2
mm

Norvinia SRL

Brasov: Str. Calea Bucuresti nr. 102, Tel/Fax: 0268-477440, Str. Turnului nr 5, Tel/Fax: 0268-548093
Bucuresti: Home Design Mall - Stand 114-115, B-dul Ghencea nr. 126-132, Tel/Fax: 021-4131157
Cluj-Napoca: Str. Calea Turzii nr. 74-76, Tel/Fax: 0264-430134
Mail: mobilier@norvinia.ro, www.norvinia.ro, J08/514/1999, CF: R11846413